

Caution

- Tie down long or wide loads at the front and rear of the vehicle with non-elastic straps. If it looks like it can catch some air, it will. **TIE IT DOWN!**
- When loading your surf gear or kayak, ensure that it is mounted correctly using the tie downs provided and is positioned centrally, parallel to the vehicle.
- Check straps periodically during travel and tighten if necessary. Replace any straps that are worn or frayed before using (see your Prorack dealer).

Important Warning

- It is critical that all Prorack racks and accessories be properly and securely attached to your vehicle. Improper attachment could result in an automobile accident, and could cause serious bodily injury or death to you or to others.
- You are responsible for securing the racks and accessories to your car, checking the attachments prior to use, and periodically inspecting the products for adjustment, wear, and damage. Therefore, you must read and understand all of the instructions and cautions supplied with your Prorack product prior to installation or use.
- If you do not understand all of the instructions and cautions, or if you have no mechanical experience and are not thoroughly familiar with the installation procedures, you should have the product installed by a professional installer such as a boat carrier specialist.

Kit Contents

Item	Component	Qty
1	J-Cradle Kayak Carrier	2
2	Base Pad	2
3	Plug	16
4	Strap	2
5	Knob	4
6	Bracket	2
7	Bail	2
8	Carriage Bolt	2
9	T-Bolt	2
10	Long Carriage Bolt	2
11	Long T-Bolt	2
12	Steel Hook	2
13	Plain Strap	2
14	Plastic Tube	2
15	Buckle	2

Minimum Crossbar Spread 61 cm

Max Load 36 kg

This product is designed to work with Prorack Aero, Standard, Trade and other Round Bars.

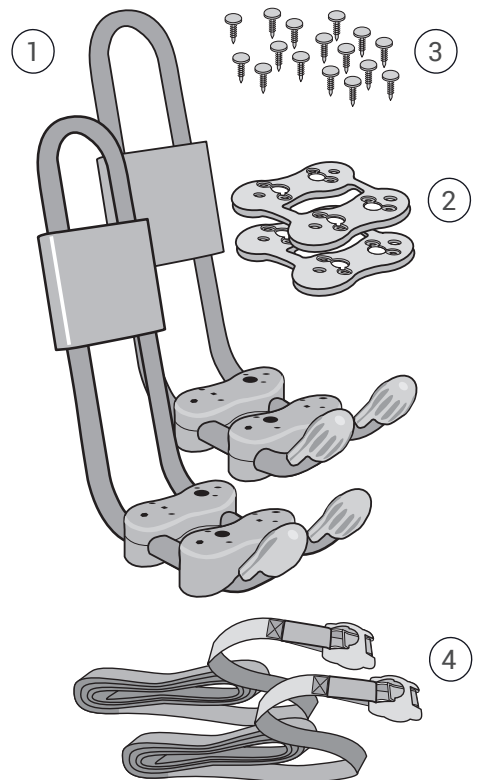
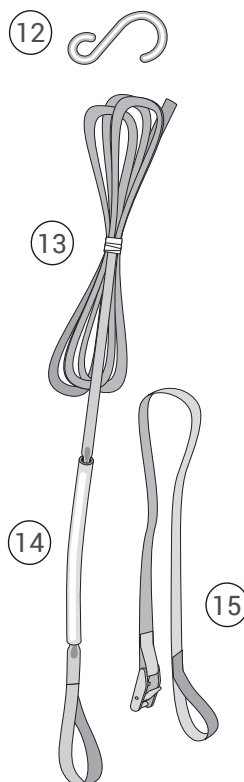
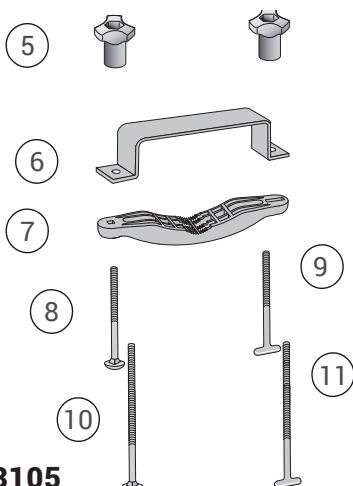

PR3105

1 Install metal bracket over bases

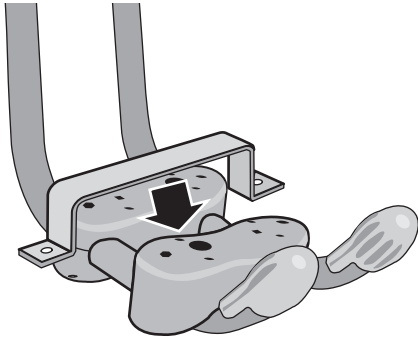

2 With brackets in place, attach pads onto bases

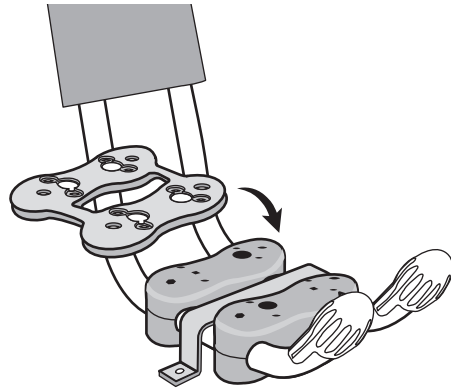

3 Attach base pads to bases with plugs

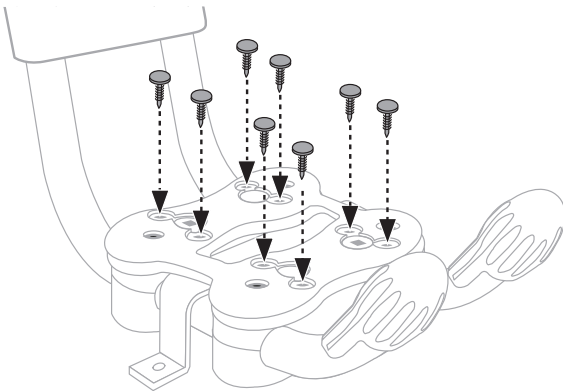

Plugs can be used only once.
If you reconfigure the bases, see your Prorack
Dealer for replacement plugs # 8890058.

4 Attach bails to metal brackets using long bolts

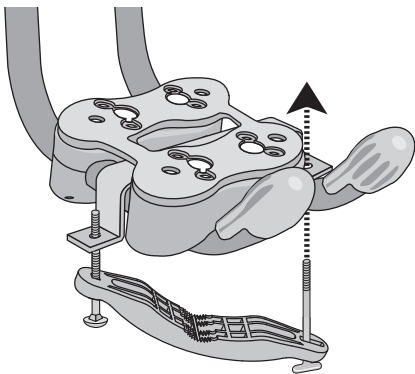

Insert bolt into round
hole, and T-bolt into
slotted hole.

5 Attach the Knobs

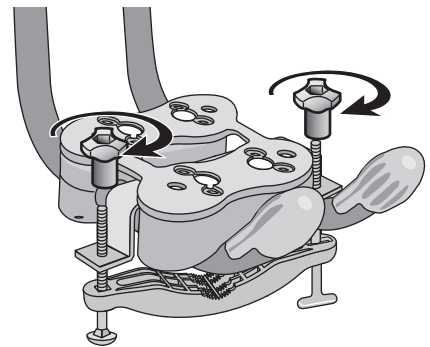

6 With the T-bolt free, position the
J-Cradles on the factory crossbars

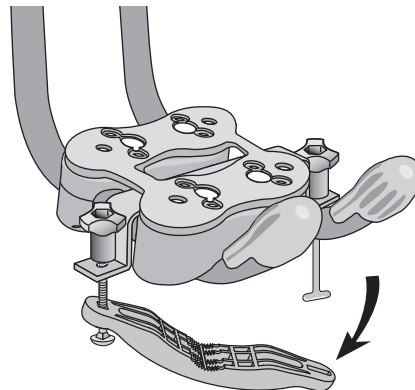

7 Ensure the carriers sit vertically on the bars

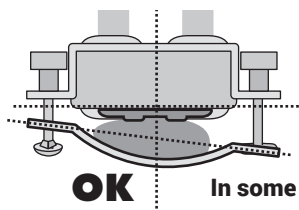
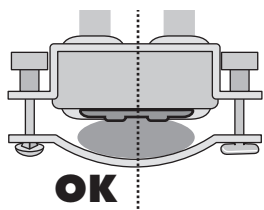

In some cases, the bracket and the bail may not be parallel

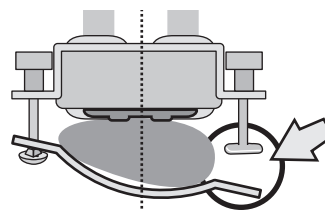

If the bolts seem too short, use the longer bolts included in this kit

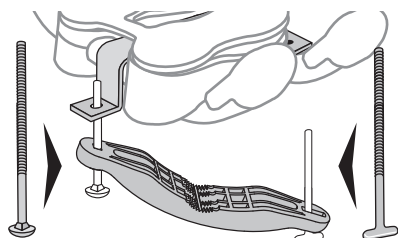

(longer bolts)



BOLTS MUST NOT EXTEND ABOVE THE KNOBS.

If bolts extend above the knob, you must use the shorter bolts

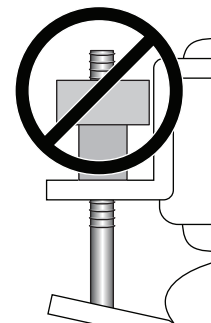

8 Tighten the Knobs

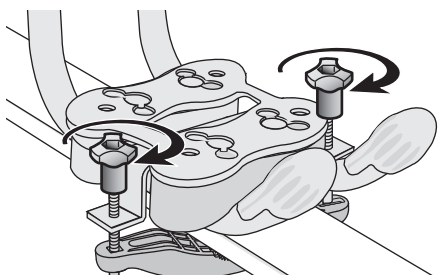

9 Adjust foam pads to support boat at contact points

Note: Some lacquer hull finishes may stick to pads. Protect with soft cloth.

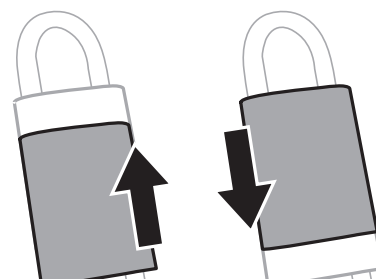

10 Load the boat, and tie it down

- Loop strap around hoop of carrier.
- Bring straps up and over boat so that they hang in front of the boat.

- Slide buckle up so that it hangs at top edge of boat.
- Thread end of strap around tower or crossbar.

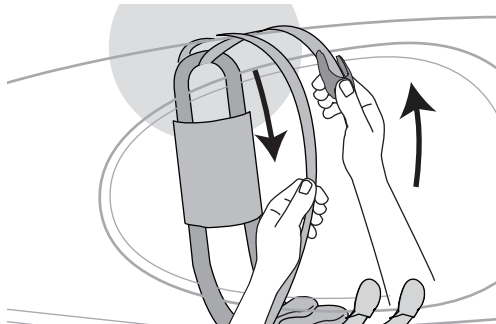

Antenna on the roof may need to be removed to prevent interference with long loads

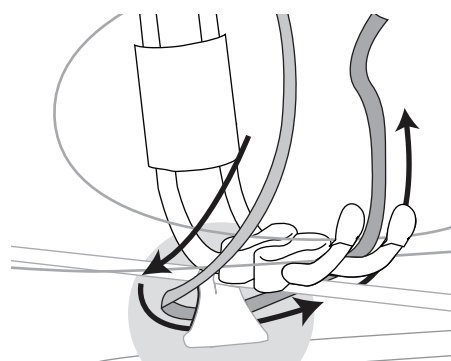

11 Secure straps

- Press open buckle and insert end of strap.

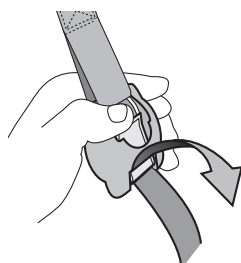

- To tighten straps, hold and pull.
- Secure the loose ends.

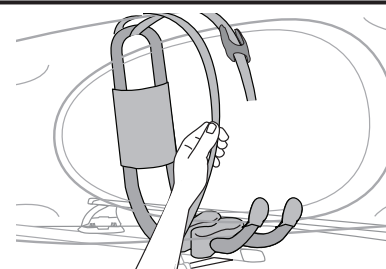

12 Attach buckle strap to bow and stern of boat

Attach strap to grab handle or rescue bar and pull tight.

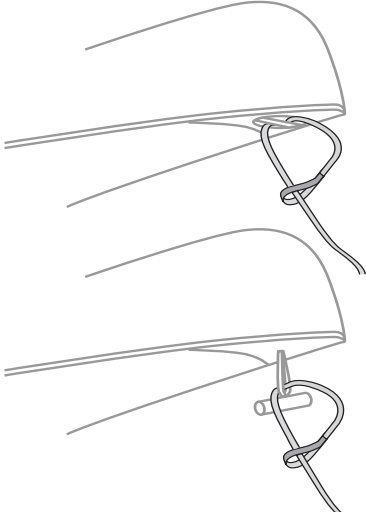

13 Attach hook to plain strap loop

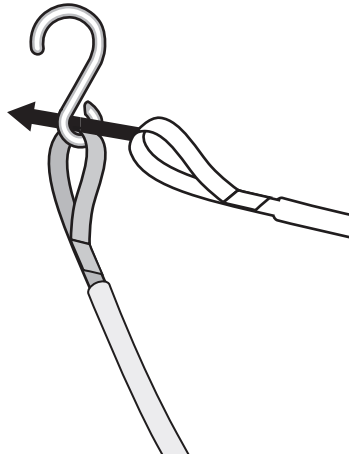

14 Hook the strap to a metal surface on the bumper, tow loop, or frame hole using hook

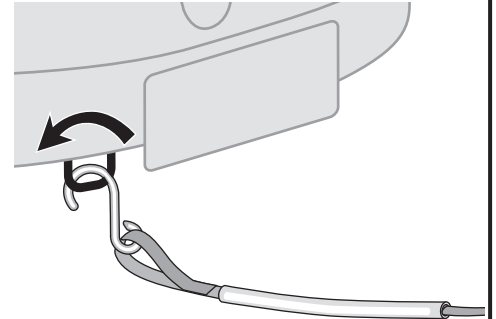

15 Slide plastic tube to protect vehicle at contact point

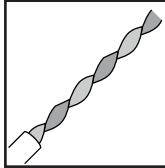

NOTE: Twisting the strap will help reduce wind vibration.

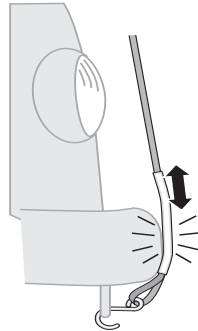

17 Adjust strap tension by pulling plain end

- Apply even pressure to front and rear straps.
- Bind up and tie off any excess strap.



16 Insert end of plain strap into buckle

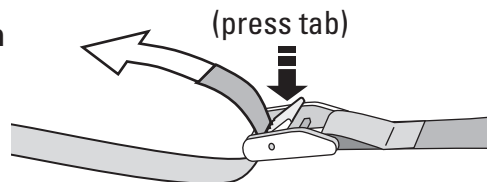

Failure to secure front and rear of long loads to ends of vehicle can result in property damage, personal injury, or death.

Safety Checks

- Before Driving Away:
 - Ensure all hardware is secured according to instructions.
 - Test movement by rocking boat.
 - Tighten again if loose.
- Attachment hardware can loosen over time:
 - Check straps periodically during travel and tighten if necessary.
 - Replace any straps that are worn or frayed before using (see your Prorack dealer).
- Some longer loads may prevent the rear hatch from fully opening.
Always use caution when opening your hatch.



Care and Maintenance

- Use non-water soluble lubricant on screws. Use a soft cloth with water and mild detergent to clean plastic parts.



Prorack
17 Hinkler Court, Brendale
QLD 4500, Australia

Freephone
AU: 1800 143 548
NZ: 0800 4776 722

www.prorack.com.au
www.prorack.co.nz

ALL CONTENT SUBJECT TO YAKIMA AUSTRALIA PTY LTD COPYRIGHT © 2015